

Bottom Mount Refrigerator—Technical Information

AFC2033DRB AFC2033DRB0, AFC2033DRQ AFC2033DRQ0, AFC2033DRS
 AFC2033DRS0, AFC2033DRW AFC2033DRW0, JFC2087HRP JFC2087HRP0,
 JFC2087HRS JFC2087HRS0

⚠ CAUTION

Due to a possibility of personal injury or property damage, always contact an authorized technician for service or repair of this refrigerator. All safety information must be followed as provided in Service Manual 16025629.

⚠ WARNING

To avoid risk of electrical shock that can cause death or severe personal injury, disconnect unit from power before servicing unless testing is required. Discharge capacitors through a 10,000 ohm resistor before handling. Wires removed during disassembly must be replaced on correct terminals to ensure proper grounding and polarization.

No-Load Performance, Controls in Normal Position

Ambient °F	Kw/24 hr ±0.4			Percent Run Time ±10%			Cycles/24 hr ±25%			Refrigerator Center Compartment Average Food Temperature ±3°F			Freezer Compartment Average Food Temperature ±3°F		
	70°	90°	110°	70°	90°	110°	70°	90°	110°	70°	90°	110°	70°	90°	110°
20 cu ft	1	1.60	2.3	30	50	65	39	35	24	38	36	35	0	0	0

Temperature Relationship Test Chart

Ambient °F	Evaporator Outlet ±3°F		Evaporator Inlet ±3°F		Suction Line ±7°F		Average Total Wattage ±10%		Suction Pressure ±2 PSIG		Head Pressure ± 5 PSIG	
	70°	90°	70°	90°	70°	90°	70°	90°	70°	90°	70°	90°
20 cu ft	-20	-17	-20	-17	85	105	125	130	6" (Vac.)	1	85	135

Schematic

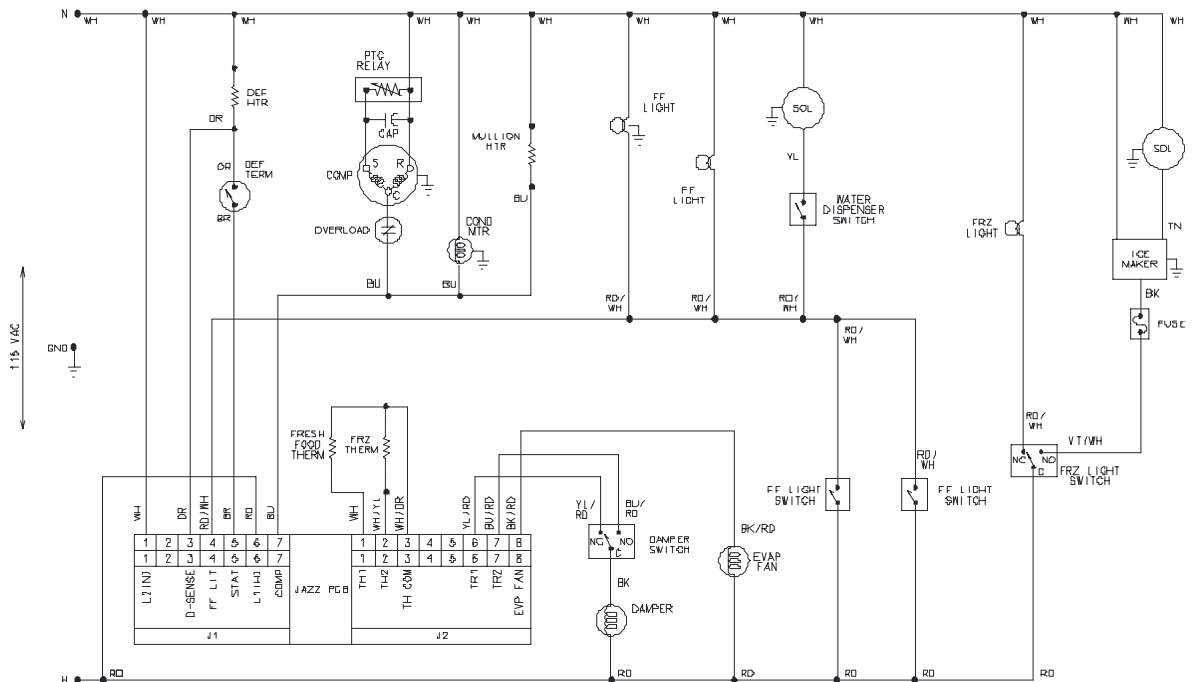

Component Specifications



WARNING

To avoid risk of electrical shock that can cause death or severe personal injury, disconnect unit from power before servicing unless tests require power. Discharge capacitors through a 10,000-ohm resistor before handling. Wires removed during disassembly must be replaced on correct terminals to ensure proper grounding and polarization.

Component	Specifications all parts 115VAC/60HZ unless noted	
Compressor run capacitor	Volt	220 VAC
	Capacitance	15 μ fd \pm 10%
Compressor	BTUH	730 BTUH
	Watt	60 Hz / 125 watts
	Current Lock rotor	19.0 amps \pm 15%
	Current Full load.....	1.09 amps \pm 15%
	Resistance Run windings.....	3.33 ohms \pm 15%
	Resistance Start windings.....	4.28 ohms \pm 15%
Electric damper control	Maximum closing time.....	36 seconds
	Temperature Rating	20°F- 110°F
	RPM	1
Thermistor	Temperature	Resistance
	77°F	10,000 ohms
	36°F	29,500 ohms
	0°F	86,300 ohms
Condenser motor	Rotation (facing end opposite shaft)	Clockwise
	RPM.....	1250 RPM
	Watt.....	8.0 watts \pm 15% @ 115VAC
	Current	0.10 amps \pm 15% @ 115VAC
Evaporator fan motor	Rotation (facing end opposite shaft)	Clockwise
	RPM.....	2800 RPM
	Watt.....	5.9 \pm 15% watts @ 115VAC
Overload/Relay	Ult. trip amps @ 158°F (70°C)	2.67 amps \pm 15%
	Close temperature.....	142°F \pm 16°
	Open temperature	284°F \pm 9°
	Short time trip (seconds)	10 seconds \pm 5
	Short time trip (amps @ 77°F (25°C) ..	11 amps \pm 2amps
Control board	Volt	120VAC, 60 HZ
	See Control Board section for diagnostics	
Thermostat (Defrost)	Volt	120/240 VAC
	Watt	495 watts
	Current	10/5 amps
	Resistance across terminals:	
	Above 42°F \pm 5°	Open
	Below 12°F \pm 7°	Closed
Evaporator heater	Volt	115 VAC
	Wattage	435 \pm 5% watts @ 115VAC
	Resistance	29 \pm 5% ohms
Mullion Assembly w/ Heater	Volt.....	120 VAC
	Wattage.....	10 \pm .5 watts @ 120VAC
	Resistance	1440 \pm 5% ohms
	Resistance checked at leads at center of hinged side of Fresh Food door.	
Water valve, dual	Volt.....	120 VAC
	Watt.....	35 watts (Brown coil)
		20 watts (Yellow coil)
Light switch	Type.....	SPST NC
	Volt.....	125/250 VAC
	Current.....	8 / 6 amps
Light switch / Interlock	Type.....	SPDT NO/NC
	Volt.....	125/250 VAC
	Current.....	5 / 2.5 amps

Service Specifications



WARNING

To avoid risk of electrical shock that can cause death or severe personal injury, disconnect unit from power before servicing unless tests require power. Discharge capacitors through a 10,000-ohm resistor before handling. Wires removed during disassembly must be replaced on correct terminals to ensure proper grounding and polarization.

Programming Mode:

Note: The Program Code is located on the Serial Plate on this unit after the word Code.

1. Open the Fresh Food door and hold the Fresh Food door light switch closed while pushing the Freezer Temperature Down  Key pad 3 times consecutively.

Note: The 3 Keystrokes must be done consecutively and within 10 seconds.

2. Release the Fresh Food door light switch.
3. The control will display PE to confirm entry into the programming mode.

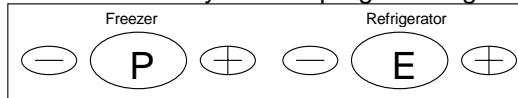



4. Entry is confirmed by pressing the Freezer Down  key once more.

Note: All control functions will be turned off (Compressor, Defrost, Evaporator Fan, the damper will remain in its current position).

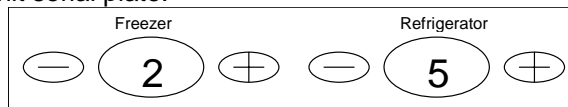
5. The control will display the current Program Code. This value should be validated with the Program Code printed on the unit serial plate.



Note: If the Program Code is correct, the Programming Mode is exited by closing the Refrigerator door(s).

6. To set the desired Program Code number press the Freezer and Refrigerator UP  keys. The corresponding digit will be advanced with each key press.
7. Once the desired Program Code is displayed, press the Freezer Down  Key until the Program Code begins flashing indicating it has been saved.

Note: If you attempt to enter an invalid Program Code the control will not save the new code, but will flash the old code and this will be displayed. (The unit will NOT run with a Program Code of 00).

8. Once the Program Code has been saved the Programming Mode is exited by closing the Refrigerator door(s). If the new code is incorrect this process should be repeated after closing the Refrigerator door(s).

The Programming mode can be exited at any time by closing the Refrigerator Door(s).

Defrost Operation:

The Control Board adapts the compressor run time between defrosts to achieve optimum defrost intervals by monitoring the length of time the defrost heater is on.

After initial power up, defrost interval is 4 hours compressor run time. Defrost occurs immediately after the 4 hours.

Note: Once unit is ready to defrost there is a 4 minute wait time prior to the beginning of the defrost cycle. Optimum defrost is 15 minutes. Each additional minute the defrost thermostat remains closed, 1 hr. is subtracted from the previous defrost interval. Each minute the thermostat opens prior to optimum defrost, it extends the next defrost interval 1 hr. When defrost thermostat opens there is a 4-6 minute drip time before compressor restarts or Control Board will terminate defrost at 25 minutes if defrost thermostat has not opened and will reset the defrost interval to the 8 hr. minimum setting.

4 hours of continuous compressor run resets the next defrost interval to 8 hours and will initiate a defrost, if 8 hours of compressor run time has also occurred.

Forced Defrost Mode:

The forced defrost function is performed using the refrigerator display and keypad. Enter the Forced Defrost Mode by performing the following sequence of events:

1. Hold the refrigerator door light switch closed.
2. Press the Refrigerator Temperature Down  keypad 3 times consecutively.

Note: The 3 keystrokes must be consecutive and within 10 seconds.

Service Specifications

WARNING

To avoid risk of electrical shock that can cause death or severe personal injury, disconnect unit from power before servicing unless tests require power. Discharge capacitors through a 10,000-ohm resistor before handling. Wires removed during disassembly must be replaced on correct terminals to ensure proper grounding and polarization.

3. Release the refrigerator door light switch.
4. The control will display Fd to confirm entry into the Forced Defrost Mode.

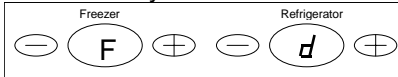

5. Entry is confirmed by pressing the Refrigerator Down  key once more. The unit is off and in the Defrost Mode.

Note: All control functions will be turned off (Compressor, Defrost, Evaporator Fan, the damper will remain in its current position).

6. The control will default to the short run period test as shown here.

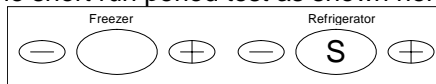

Note: You can toggle between the (S)hort and (L)ong test mode by pressing the Refrigerator UP  Key. Long Test mode is used for factory test and should not be used in the field.

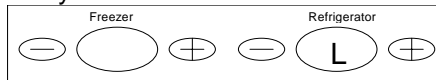

7. Once the desired mode is displayed, confirm the forced defrost by pressing the Refrigerator  down Key once. The defrost will begin immediately and the display will return to a normal operating display with set point values.

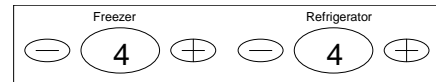

8. Close the Refrigerator door(s). You are in the defrost mode.

Note: Forced Defrost mode can be exited at any time prior to step 7 by closing the Refrigerator Door(s).

Service Test Mode:

The service test functions are performed using the refrigerator display and keypad. Enter the Service Test Mode by performing the following sequence of events:

1. Hold the refrigerator door light switch closed.
2. Press the Refrigerator Temperature Up  keypad 3 times consecutively.

Note: The 3 Keystrokes must be done consecutively and within 10 seconds.

3. Release the refrigerator door light switch.
4. The control will display SE to confirm entry into the service mode.

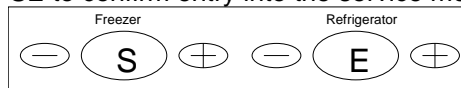

5. Entry to the Service Menu is confirmed by pressing the Refrigerator Up  key once more.
6. The control will display its software version for 3 seconds.

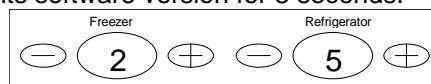

7. Following the software revision display the freezer display will read the first test number in the diagnostic tree. The refrigerator display will be blank.

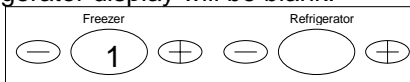

Note: All control functions will be turned off (Compressor, Defrost, Evaporator Fan, the damper will remain in its current position).

8. You are now in the SERVICES TEST operational mode and may use the diagnostic tests.

The Service Test Mode can be exited at any time by closing the Refrigerator Door(s).

Service Specifications



WARNING

To avoid risk of electrical shock that can cause death or severe personal injury, disconnect unit from power before servicing unless tests require power. Discharge capacitors through a 10,000-ohm resistor before handling. Wires removed during disassembly must be replaced on correct terminals to ensure proper grounding and polarization.

Service Test 1 – Defrost Thermostat & Defrost Circuit Test

When selected this test will display the state of the defrost thermostat. In order to perform this test the defrost heater will be energized. The test is activated and deactivated using the Refrigerator Up \oplus key. Once activated, this test must be deactivated to move to another test number. The Freezer Up \oplus / Down \ominus keys allow selection of the test to be performed.

This test also allows observation and measurement of proper defrost function. You can observe defrost heat and voltages while the test is activated.

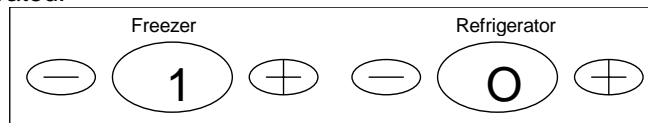

DEFROST THERMOSTAT OPEN

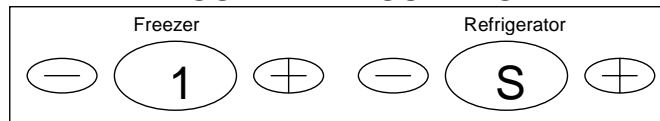

DEFROST THERMOSTAT SHORTED (CLOSED)

Service Test 2 – Compressor/Condenser Fan Test

When selected and activated this test will operate the Compressor/Condenser Fan circuit. You should evaluate proper operation of the compressor and condenser fan. The Refrigerator Up \oplus key will toggle between "O" / "F" (ON & OFF) the compressor drive circuit. The test must be "deactivated" or in the OFF position to move to another test selection.

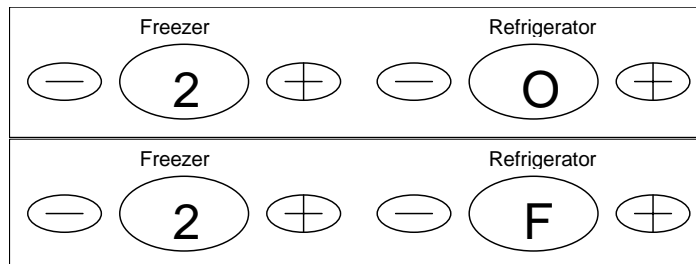

OBSERVE COMPRESSOR & CONDENSER FAN FUNCTION

Service Test 3 – Evaporator/Freezer Fan Test

When selected and activated this test will operate the freezer fan. The Refrigerator Up \oplus key will toggle between "O" / "F" (ON & OFF) the fan drive circuit. You will have to inspect the fan for proper function. The test must be "deactivated" or in the OFF position to move to another test selection.

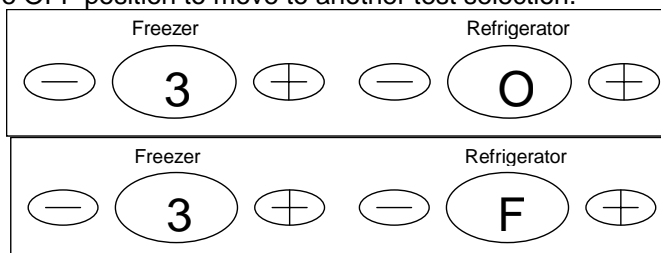

OBSERVE FAN OPERATION

Service Specifications



WARNING

To avoid risk of electrical shock that can cause death or severe personal injury, disconnect unit from power before servicing unless tests require power. Discharge capacitors through a 10,000-ohm resistor before handling. Wires removed during disassembly must be replaced on correct terminals to ensure proper grounding and polarization.

Service Test 4 – Fresh Food Thermistor Test

When selected and activated this test will display Pass, Open, Short result for a test on the Fresh Food Thermistor circuit as shown below. The test is activated and deactivated via the Refrigerator Up  key, and must be deactivated to move to another test selection.

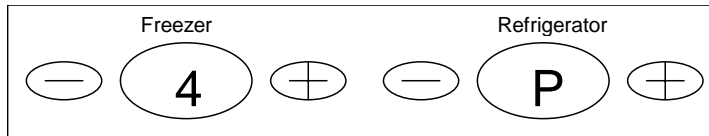

PASS RESULT

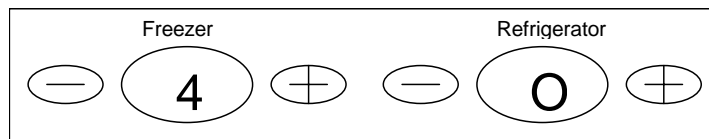

OPEN RESULT

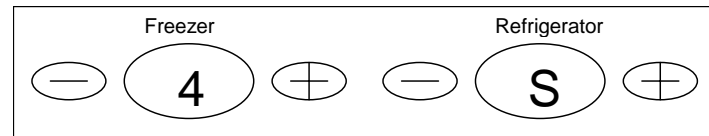

SHORT RESULT

Service Test 5 – Freezer Thermistor Test

When selected this test will display Pass, Open, Short result for a test on the Freezer Thermistor circuit as shown below. The test is activated and deactivated via the Refrigerator Up  key, and must be deactivated to move to another test selection.

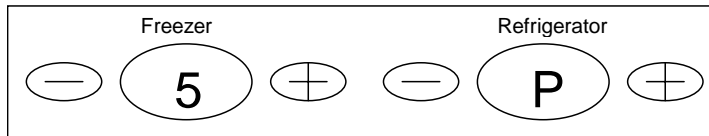

PASS RESULT

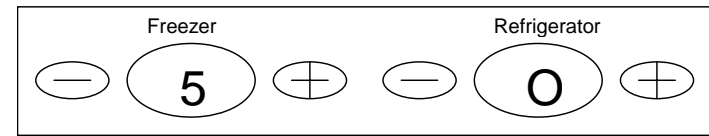

OPEN RESULT

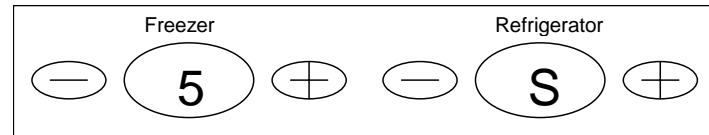

SHORT RESULT

Service Specifications



WARNING

To avoid risk of electrical shock that can cause death or severe personal injury, disconnect unit from power before servicing unless tests require power. Discharge capacitors through a 10,000-ohm resistor before handling. Wires removed during disassembly must be replaced on correct terminals to ensure proper grounding and polarization.

Service Test 6 – Open Damper Test

When selected this test will indicate the current position “O” / “C” (OPEN / CLOSED) of the refrigerator damper. The Refrigerator Up \oplus key will toggle the damper open and closed. You must allow 1 minute for each attempt to change the damper position. You should observe proper damper function.

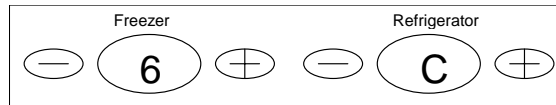
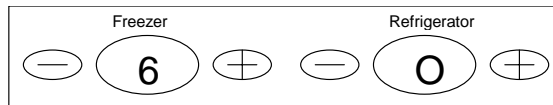

OBSERVE DAMPER FUNCTION



CAUTION

Adjustments of Service Test 7 or Service Test 8 will alter the performance of the unit.

Service Test 7 – FF Performance Adjustment

This test will allow adjustment of the control performance points. Each step will incrementally change the Refrigerator performance warmer (towards 1) or colder (towards 9) as adjusted. The default value is 5.

The refrigerator \oplus / \ominus Up/Down keys are used to adjust the Performance Offset value.

WARMER \leftarrow (1 2 3 4 (5) 6 7 8 9) \rightarrow COLDER.

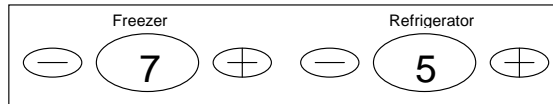

DEFAULT

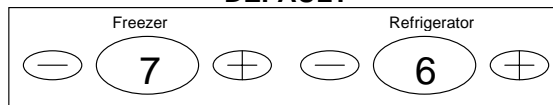

COLDER

The last FF Performance Offset value displayed before leaving test 7 will be saved when the refrigerator door(s) is closed.

Service Test 8 – FZ Performance Adjustment

This test will allow the adjustment of the control performance points. Each step will incrementally change the Freezer performance warmer (towards 1) or colder (towards 9) as adjusted. The default value is 5.

The refrigerator \oplus / \ominus Up/Down keys are used to adjust the Performance Offset value.

WARMER \leftarrow (1 2 3 4 (5) 6 7 8 9) \rightarrow COLDER.

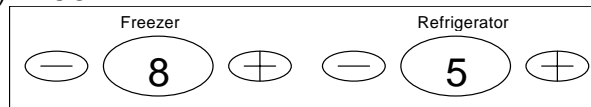

DEFAULT

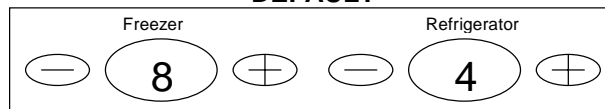

WARMER

The last FZ Performance Offset value displayed before leaving test 8 will be saved when the refrigerator door(s) is closed.

Wiring Diagram

WARNING

To avoid risk of electrical shock that can cause death or severe personal injury, disconnect unit from power before servicing unless tests require power. Discharge capacitors through a 10,000-ohm resistor before handling. Wires removed during disassembly must be replaced on correct terminals to ensure proper grounding and polarization.

See Note below
about alternate wiring
of Refrigerator door harness

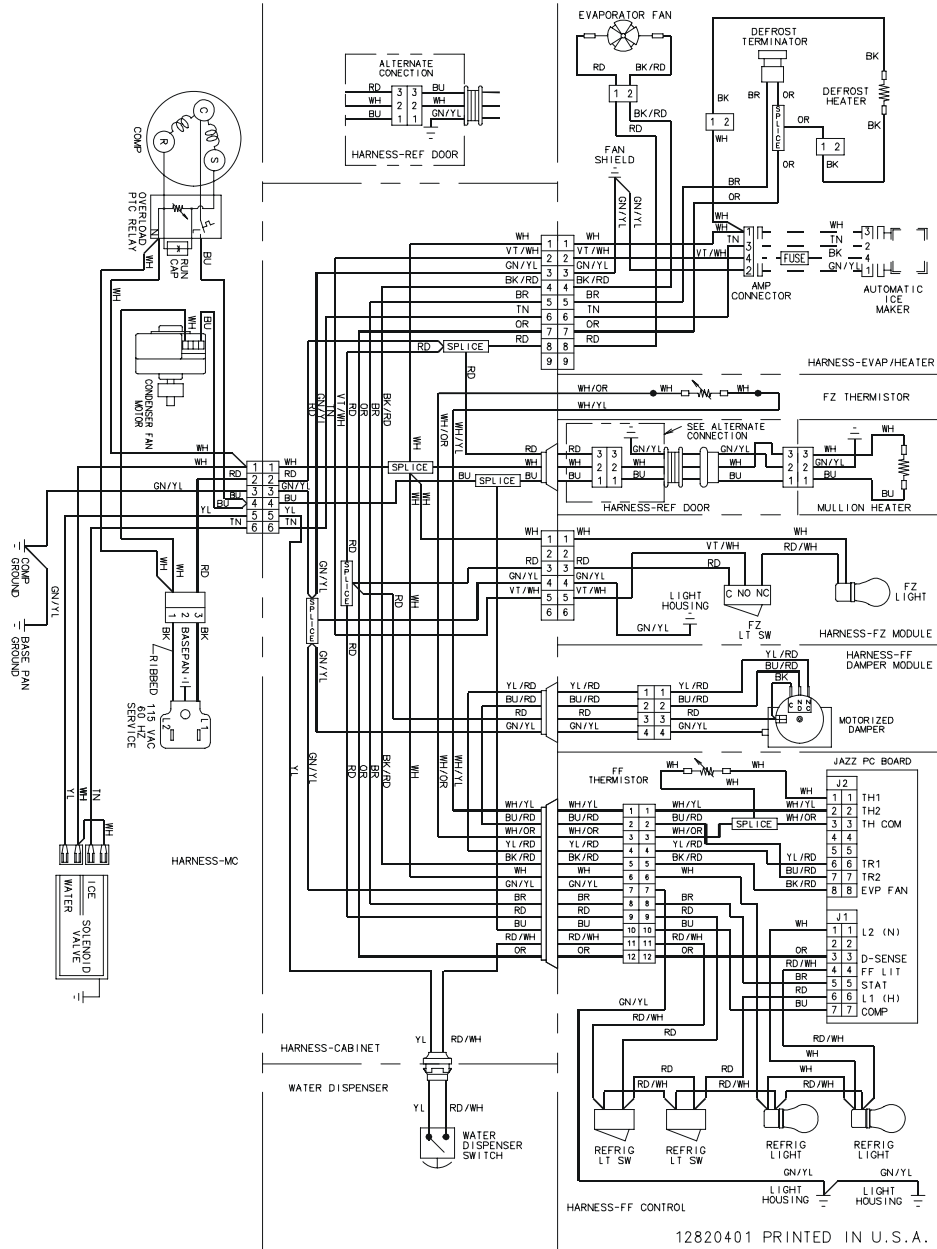

12820401 PRINTED IN U.S.A.

Note: In the event of excessive moisture on fresh food door mullion, the red and blue cabinet wires to door harness can be reversed to power fresh food door mullion heater continuously. This will help to reduce moisture on fresh food door mullion. See wiring alternate above for wiring in mullion heater for continuous operation.